



**HIRSCHMANN**

A **BELDEN** BRAND

# User Manual

Industrial Protocols

Industrial ETHERNET (Gigabit-)Switch

MACH 100, MACH 1000, MACH 4000, MS20/MS30, OCTOPUS,  
PowerMICE, RS20/RS30/RS40, RSR20/RSR30

The naming of copyrighted trademarks in this manual, even when not specially indicated, should not be taken to mean that these names may be considered as free in the sense of the trademark and tradename protection law and hence that they may be freely used by anyone.

© 2013 Hirschmann Automation and Control GmbH

Manuals and software are protected by copyright. All rights reserved. The copying, reproduction, translation, conversion into any electronic medium or machine scannable form is not permitted, either in whole or in part. An exception is the preparation of a backup copy of the software for your own use. For devices with embedded software, the end-user license agreement on the enclosed CD/DVD applies.

The performance features described here are binding only if they have been expressly agreed when the contract was made. This document was produced by Hirschmann Automation and Control GmbH according to the best of the company's knowledge. Hirschmann reserves the right to change the contents of this document without prior notice. Hirschmann can give no guarantee in respect of the correctness or accuracy of the information in this document.

Hirschmann can accept no responsibility for damages, resulting from the use of the network components or the associated operating software. In addition, we refer to the conditions of use specified in the license contract.

You can get the latest version of this manual on the Internet at the Hirschmann product site ([www.hirschmann.com](http://www.hirschmann.com)).

Printed in Germany  
Hirschmann Automation and Control GmbH  
Stuttgarter Str. 45-51  
72654 Neckartenzlingen  
Germany  
Tel.: +49 1805 141538

# Contents

	About this Manual	5
	Key	7
1	Industry Protocols	9
2	EtherNet/IP	13
2.1	Integration into a Control System	15
2.2	EtherNet/IP Parameters	19
2.2.1	Identity Object	19
2.2.2	TCP/IP Interface Object	20
2.2.3	Ethernet Link Object	22
2.2.4	Ethernet Switch Agent Object	25
2.2.5	RSTP Bridge Object	28
2.2.6	RSTP Port Object	29
2.2.7	I/O Data	30
2.2.8	Assignment of the Ethernet Link Object Instances	31
2.2.9	Supported Services	32
3	PROFINET IO	33
3.1	Integration into a Control System	36
3.1.1	Preparing the Switch	36
3.1.2	Configuration of the PLC	37
3.1.3	Configuring the device	47
3.1.4	Swapping devices	48
3.1.5	Swapping modules	49
3.1.6	Monitoring the network	50
3.2	PROFINET IO Parameters	54
3.2.1	Alarms	54
3.2.2	Record parameters	54
3.2.3	I/O Data	58
4	IEC 61850/MMS (RSR20/RSR30/MACH1000)	61
4.1	Switch model for IEC 61850	62
4.2	Integration into a Control System	64
4.2.1	Preparing the Switch	64
4.2.2	Offline configuration	65

	4.2.3 Monitoring the device	66
A	GSD File Generator	67
B	Readers' Comments	68
C	Index	71
D	Further Support	73

# About this Manual

The “Industry Protocols” user manual describes how the device is connected by means of a communication protocol commonly used in the industry, such as EtherNet/IP and PROFINET IO.

The following thematic sequence has proven itself in practice:

- ▶ Device configuration in line with the “Basic Configuration” user manual
- ▶ Check on the connection Switch <--> PLC
- ▶ Program the PLC

The “Installation” user manual contains a device description, safety instructions, a description of the display, and the other information that you need to install the device.

The “Redundancy Configuration” user manual document contains the information you require to select the suitable redundancy procedure and configure it.

You will find detailed descriptions of how to operate the individual functions in the “Web-based Interface” and “Command Line Interface” reference manuals.

The Industrial HiVision Network Management Software provides you with additional options for smooth configuration and monitoring:



- ▶ Simultaneous configuration of multiple devices
- ▶ Graphical user interface with network layout
- ▶ Auto-topology discovery
- ▶ Event log
- ▶ Event handling
- ▶ Client/server structure
- ▶ Browser interface
- ▶ ActiveX control for SCADA integration
- ▶ SNMP/OPC gateway.



# Key

The designations used in this manual have the following meanings:







---

	List
<input type="checkbox"/>	Work step
	Subheading
<a href="#">Link</a>	Cross-reference with link
<b>Note:</b>	A note emphasizes an important fact or draws your attention to a dependency.
<code>Courier</code>	ASCII representation in user interface

---

Symbols used:

---

	WLAN access point
	Router with firewall
	Switch with firewall
	Router
	Switch
	Bridge

---

# Key

---



Hub



A random computer



Configuration Computer



Server



PLC -  
Programmable logic  
controller



I/O -  
Robot

---



# 1 Industry Protocols

For a long time, automation communication and office communication were on different paths. The requirements and the communication properties were too different.

Office communication moves large quantities of data with low demands with respect to the transfer time. Automation communication moves small quantities of data with high demands with respect to the transfer time and availability.

While the transmission devices in the office are usually kept in temperature-controlled, relatively clean rooms, the transmission devices used in automation are exposed to wider temperature ranges. Dirty, dusty and damp ambient conditions make additional demands on the quality of the transmission devices.

With the continued development of communication technology, the demands and the communication properties have moved closer together. The high bandwidths now available in Ethernet technology and the protocols they support enable large quantities to be transferred and exact transfer times to be defined.

With the creation of the first optical LAN to be active worldwide, at the University of Stuttgart in 1984, Hirschmann laid the foundation for industry-compatible office communication devices. Thanks to Hirschmann's initiative with the world's first rail hub in the 1990s, Ethernet transmission devices such as switches, routers and firewalls are now available for the toughest automation conditions.

The desire for uniform, continuous communication structures encouraged many manufacturers of automation devices to come together and use standards to aid the progress of communication technology in the automation sector. This is why we now have protocols that enable us to communicate via Ethernet from the office right down to the field level.

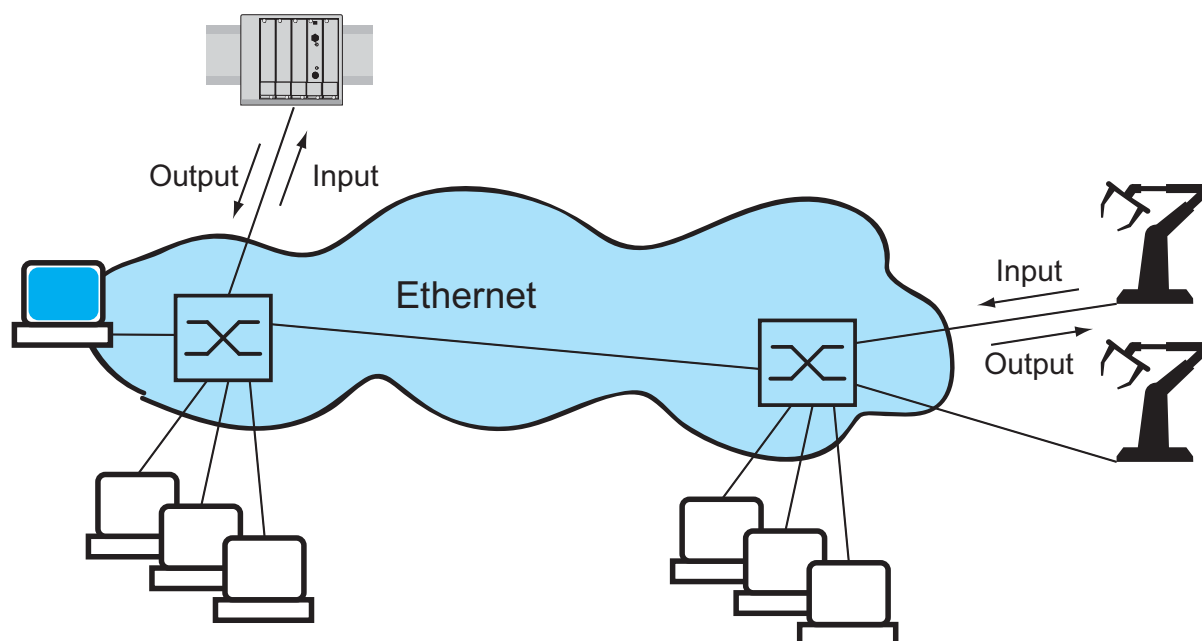

Figure 1: Example of communication.

Hirschmann switches support the following industry protocols and systems

- ▶ EtherNet/IP
- ▶ PROFINET IO

Depending on the ordered Industrial Protocol variant the Switch offers the suitable default settings:

Settings / Variant	Standard	EtherNet/IP	PROFINET IO
Order code	H	E	P
EtherNet/IP	0	1	0
IGMP Snooping	0	1	0
IGMP Querier	0	1	0
Unknown Multicast	Send To All Ports	Discard	Discard
Address Conflict Detection	0	1	0
RSTP	1	0	1
DIP switch	SW-Konfig	SW-Konfig	SW-Konfig
100 Mbit/s TP ringports	Autoneg	Autoneg	Autoneg

Settings / Variant	Standard	EtherNet/IP	PROFINET IO
Static Query Port	Disable	Automatic	Automatic
PROFINET IO	0	0	1
Boot-Modus	DHCP	DHCP	Lokal
VLAN 0 Transparent Modus	0	0	1
HiDiscovery	Read/Write	Read/Write	ReadOnly
sysName	Product name + 3 Byte MAC	Product name + 3 Byte MAC	empty

If you want to configure a device with the standard configuration for PROFINET IO, you will find the corresponding dialogs of the Web-basedInterface in the following table.

Parameter	Dialog	Action
PROFINET IO	Advanced:Industrial Protcols	Activate PROFINET IO.
Boot Mode	Basic Settings:Network/Mode	Select "Local".
IP Address	Basic Settings:Network/Local	Enter the "IP address" 0.0.0.0.
Netmask	Basic Settings:Network/Local	Enter the "netmask" 0.0.0.0.
Gateway Address	Basic Settings:Network/Local	Enter the "gateway address" 0.0.0.0.
VLAN 0 Transparent	Switching:VLAN:Global	Activate the "VLAN 0 transparent mode".
HiDiscovery	Basic Settings:Network/HiDisco very Protocol	Activate the function and select "Read only" access.
System Name	Basic Settings: System/System data	Delete the field content.

*Table 1: Web-based interface dialogs for setting the PROFINET IO parameters*



## 2 EtherNet/IP

EtherNet/IP, which is accepted worldwide, is an industrial communication protocol standardized by the Open DeviceNet Vendor Association (ODVA) on the basis of Ethernet. It is based on the widely used transport protocols TCP/IP and UDP/IP (standard). EtherNet/IP thus provides a wide basis, supported by leading manufacturers, for effective data communication in the industry sector.

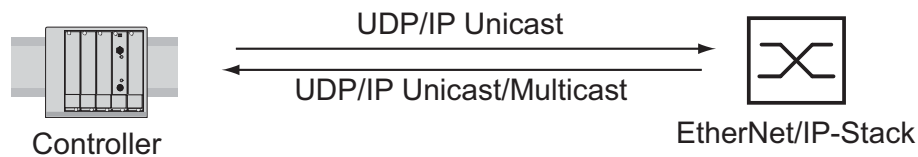

*Figure 2: Communication between the controller (PLC) and the Switch*

EtherNet/IP adds the industry protocol CIP (Common Industrial Protocol) to the Ethernet as an application level for automation applications. Ethernet is thus ideally suited to the industrial control technology sector.

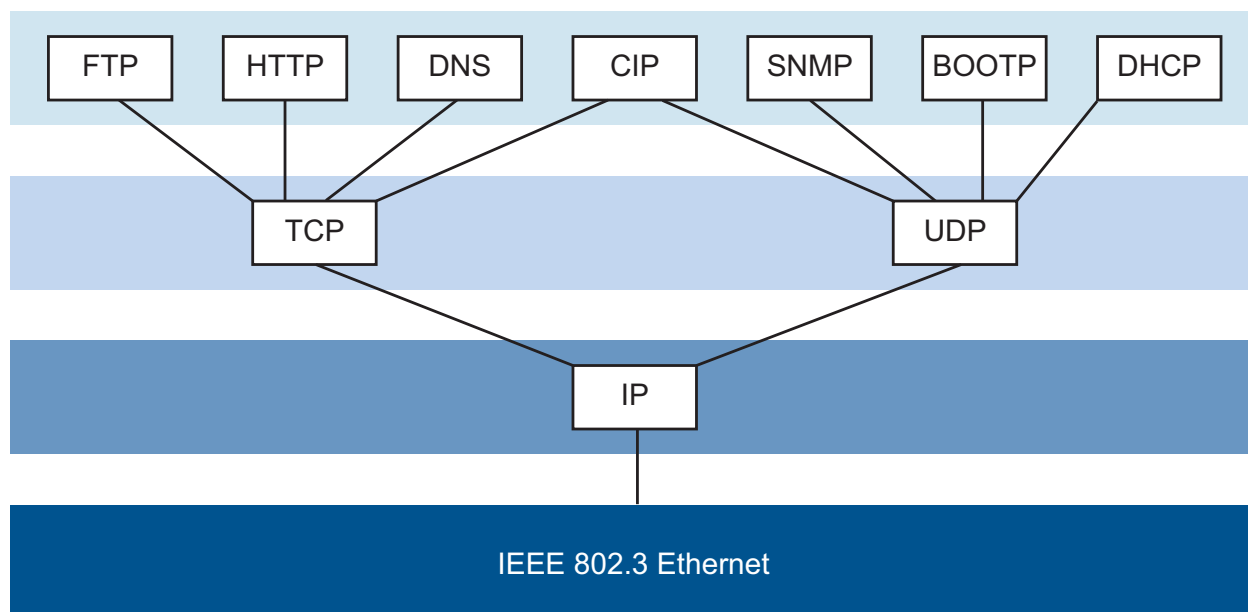

Figure 3: EtherNet/IP (CIP) in the ISO/OSI reference model

In particular, you will find EtherNet/IP in the USA and in conjunction with Rockwell controllers.

For detailed information on EtherNet/IP, see the Internet site of ODVA at [www.ethernetip.de](http://www.ethernetip.de).

## 2.1 Integration into a Control System

After installing and connecting the Switch, you configure it according to the “Basic Configuration” user manual. Then:

- Use the Web-based interface in the `Switching:Multicasts:IGMP` dialog to check whether the IGMP Snooping is activated.
- Use the Web-based interface in the `Advanced:Industry Protocols` dialog to check whether EtherNet/IP is activated.
- Use the Web-based interface in the `Advanced:Industry Protocols` dialog to download the EDS (EtherNet/IP configuration file) and the icon to your local computer.

**Note:** If EtherNet/IP and the router function are switched on at the same time, malfunctions could occur with EtherNet/IP, for example, in connection with “RS Who”. Therefore, you should switch off the router function of the device.

- ▶ Switch off the router function in the Web-based interface:  
`Routing:Global` dialog.
- ▶ Switch off the router function in the Command Line interface:  
in the configuration mode (prompt “`..(Config)#`”) with the command  
`no ip routing`.

- Configuration of a PLC using the example of Rockwell software
  - Open the “EDS Hardware Installation Tool” of RSLinx.
  - Use the “EDS Hardware Installation Tool” to add the EDS file.
  - Restart the “RSLinx” service so that RSLinx takes over the EDS file of the Switch.
  - Use RSLinx to check whether RSLinx has detected the Switch.
  - Open your Logix 5000 project.
  - Integrate the Switch into the Ethernet port of the controller as a new module (Generic Ethernet Module).

Setting	I/O connection	Input only	Listen only
Comm Format:	Data - DINT	Data - DINT	Input data - DINT - Run/Program
IP Address	IP address of the Switch	IP address of the Switch	IP address of the Switch
Input Assembly Instance	2	2	2
Input Size	7 (MACH 4000: 11)	7 (MACH 4000: 11)	7 (MACH 4000: 11)
Output Assembly Instance	1	254	255
Output Size	1 (MACH 4000: 2)	0	0
Configuration Assembly Instance	3	3	3
Configuration Size	0	0	0

*Table 2: Settings for integrating a Generic Ethernet Module*



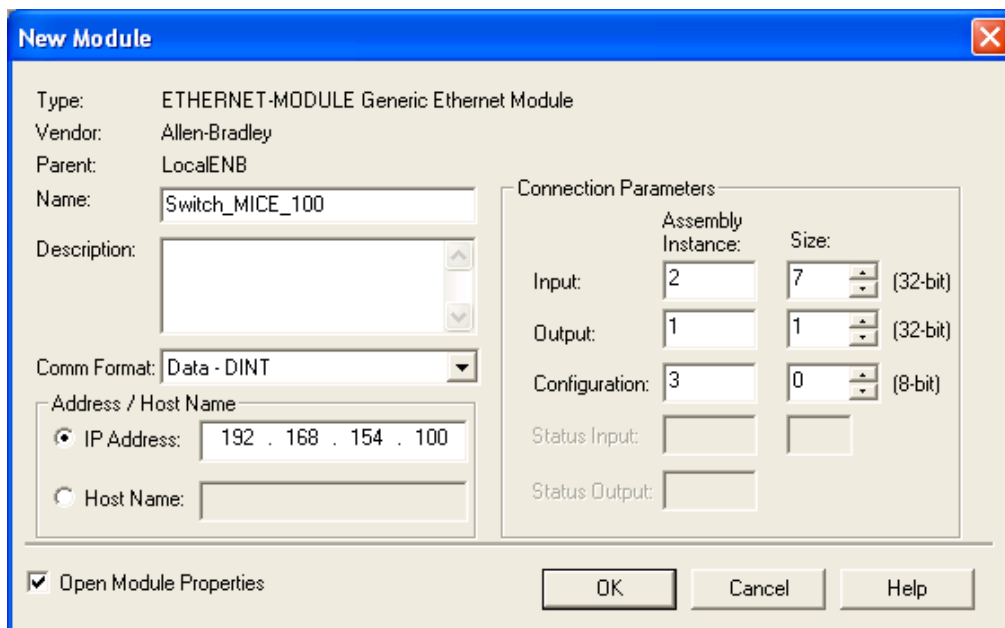

Figure 4: Integrating a new module into Logix 5000

- In the module properties, enter a value of at least 100 ms for the Request Packet Interval (RPI).

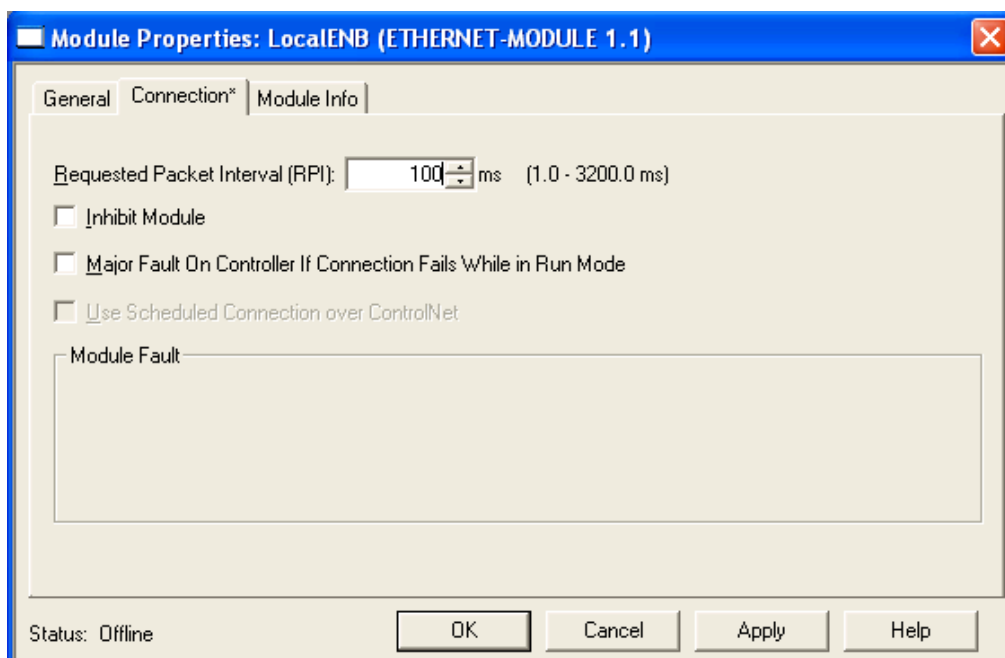

Figure 5: Module properties for the Request Packet Interval (RPI)

**Note:** If for example, a management program is occupying the Switch CPU with SNMP requests, the I/O connection between the programmable logic controller (PLC) and the Switch can be interrupted for a time. As the Switch can still transmit data packages in this case, the system can also still be ready for operation.

The monitoring of the I/O connection to the Switch CPU as a failure criterion can result in system failure and is therefore less suitable as a failure criterion.

- Example of integration from the Sample Code Library  
The Sample Code Library is a website from Rockwell. The object of the website is to provide users with a place where they can exchange their best architecture integration applications.  
On the website <http://samplecode.rockwellautomation.com>, search for catalog number 9701. This is the catalog number of an example for integrating HirschmannSwitches into RS Logix 5000 rel. 16, PLC firmware release 16.

## 2.2 EtherNet/IP Parameters

### 2.2.1 Identity Object

The Switch supports the identity object (class code 01) of EtherNet/IP. The Hirschmann manufacturer ID is 634. Hirschmann uses the manufacturer-specific ID 149 (95H) to indicate the product type “Managed Ethernet Switch”.

ID	Attribute	Access Rule	Data Type	Description
1	Vendor ID	Get	UINT	Hirschmann 634
2	Device Type	Get	UINT	Vendor-specific Definition 149 (95H) “Managed Ethernet Switch”.
3	Product Code	Get	UINT	Product Code: mapping is defined for every device type, e.g. RS20-0400T1T1SDAPHH is 16650.
4	Revision	Get	STRUCT USINT Major USINT Minor	Revision of the Ethernet/IP implementation, currently 1.1, Major Revision and Minor Revision
5	Status	Get	WORD	Not used
6	Serial Number	Get	UDINT	Serial number of the device (contains last 3 bytes of MAC address).
7	Product Name	Get	Short String (max. 32 bytes)	Displayed as "Hirschmann" + order code, e.g. Hirschmann RSxxxxx.

*Table 3: Identity Object*

### 2.2.2 TCP/IP Interface Object

The Switch supports an instance (instance 1) of the TCP/IP Interface Object (Class Code F5<sub>H</sub>, 245) of EtherNet/IP.

In the case of write access, the Switch stores the complete configuration in its flash memory. Saving can take 10 seconds. If the save process is interrupted, for example, by a power cut, the Switch may become inoperable.

**Note:** The Switch replies to the configuration change "Set Request" with a "Response" although saving of the configuration has not yet been completed.

Id	Attribute	Access rule	Data type	Description
1	Status	Get	DWORD	Interface Status (0: Interface not configured, 1: Interface contains valid config).
2	Interface Capability flags	Get	DWORD	Bit 0: BOOTP Client, Bit 1: DNS Client, Bit 2: DHCP Client, Bit 3: DHCP-DNS Update, Bit 4: Configuration settable (within CIP). Other bits reserved (0).
3	Config Control	Set/Get	DWORD	Bits 0 through 3: Value 0: using stored config, Value 1: using BOOTP, Value 2: using DHCP. Bit 4: 1 device uses DNS for name lookup (always 0 because not supported) Other bits reserved (0).
4	Physical Link Object	Get	Structure: UINT Path size EPATH Path	Path to the Physical Link Objekt, always {20H, F6H, 24H, 01H} describing instance 1 of the Ethernet Link Object.

Table 4: TCP/IP Interface Object

<b>Id</b>	<b>Attribute</b>	<b>Access rule</b>	<b>Data type</b>	<b>Description</b>
5	Interface Configuration	Set/Get	Structure: UDINT IP address UDINT Netmask UDINT Gateway address UDINT Name server 1 UDINT Name server 2 STRING Domain name	IP Stack Configuration (IP-Address, Netmask, Gateway, 2 Nameservers (DNS, not supported) and the domain name).
6	Host name	Set/Get	STRING	Host name (for DHCP DNS Update).
8	TTL Value	Set/Get	USINT	TTL value for EtherNet/IP multicast packets
9	Mcast Config	Set/Get	STRUCT of:	IP multicast address configuration
	Alloc Control		USINT	Multicast address allocation control word. Determines how addresses are allocated.
	Reserved		USINT	Reserved for future use
	Num Mcast		UINT	Number of IP multicast addresses to allocate for EtherNet/IP
	Mcast Start Addr		UDINT	Starting multicast address from which to begin allocation.
100	Quick Connect	Set/Get	DWORD	Bitmask of 1 bit per port to enable/disable Quick Connect.

*Table 4: TCP/IP Interface Object*

### 2.2.3 Ethernet Link Object

The Switch supports at least one instance (Instance 1; the instance of the CPU Ethernet interface) of the Ethernet Link Object (Class Code F6<sub>H</sub>, 246) of EtherNet/IP.

Id	Attribute	Access rule	Data type	Description
1	Interface Speed	Get	UDINT	Used interface speed in MBits/s (10, 100, 1000, ...). 0 is used when the speed has not been determined or is invalid because of detected problems.
2	Interface Flags	Get	DWORD	Interface Status Flags: Bit 0: Link State (1: Link up), Bit 1: 0: Half-Duplex, 1: FullDuplex1, Bits 2 through 4: Autoneg Status (0: Autoneg in Progress, 1: Autoneg unsuccessful, 2: unsuccessful but Speed detected, 3: Autoneg success, 4: No Autoneg), Bit 5: manual configuration requires reset (always 0 because not needed), Bit 6: detected hardware error.
3	Physical Address	Get	ARRAY of 6 USINTs	MAC address of physical interface.
4	Interface Counters	Get	Struct MIB II Counters Jewels UDINT	InOctets, InUcastPackets, InNUcastPackets, InDiscards, InErrors, InUnknownProtos, OutOctets, OutUcastPackets, OutNUcastPackets, OutDiscards, OutErrors.
5	Media Counters	Get	Struct Ethernet MIB Counters Jewels UDINT	Alignment Errors, FCS Errors, Single Collision, Multiple Collision, SQE Test Errors, Deferred Transmissions, Late Collisions, Excessive Collisions, MAC TX Errors, Carrier Sense Errors, Frame Too Long, MAC RX Errors.
6	Interface Control	Get/Set	Struct Control Bits WORD Forced Iface Speed UINT	Control Bits: Bit 0: Autoneg enable/disable (1: enable), Bit 1: Duplex mode (1: full duplex, if Autoneg is disabled). Interface speed in MBits/s: 10, 100,..., if Autoneg is disabled.
7	Interface Type	Get	USINT	Value 0: Unknown interface type, Value 1: The interface is internal, Value 2: Twisted-pair, Value 3: Optical fiber.

Table 5: Ethernet Link-Objekt

<b>Id</b>	<b>Attribute</b>	<b>Access rule</b>	<b>Data type</b>	<b>Description</b>
8	Interface State	Get	USINT	Value 0: Unknown interface state, Value 1: The interface is enabled, Value 2: The interface is disabled, Value 3: The interface is testing,
9	Admin State	Set	USINT	Value 1: Enable the interface, Value 2: Disable the interface.
10	Interface Label	Get	SHORT_STRING	Interface name. The content of the string is vendor-specific.

*Table 5: Ethernet Link-Objekt*

The Switch supports additional vendor specific attributes.

<b>Id</b>	<b>Attribute</b>	<b>Access rule</b>	<b>Data type</b>	<b>Description</b>
100 (64 H)	Ethernet Interface Index	Get	UDINT	Interface/Port Index (ifIndex from MIB II)
101 (65 H)	Port Control	Get/Set	DWORD	Bit 0 (RO): Link state (0: link down, 1: link up) Bit 1 (R/W): Link admin state (0: disabled, 1: enabled) Bit 8 (RO:): Access violation alarm Bit 9 (RO): Utilization alarm
102 (66 H)	Interface Utilization	Get	UDINT	The existing Counter from the private MIB hmlfaceUtilization is used. Utilization in percentage <sup>a</sup> . RX Interface Utilization.
103 (67 H)	Interface Utilization Alarm Upper Threshold	Get/Set	UDINT	Within this parameter the variable hmlfaceUtilizationAlarmUpperThreshold can be accessed. Utilization in percentage <sup>a</sup> . RX Interface Utilization Upper Limit.
104 (68 H)	Interface Utilization Alarm Lower Threshold	Get/Set	UDINT	Within this parameter the variable hmlfaceUtilizationAlarmLowerThreshold can be accessed. Utilization in percentage <sup>a</sup> . RX Interface Utilization Lower Limit.

*Table 6: Hirschmann-Erweiterungen des Ethernet Link-Objekts*

Id	Attribute	Access rule	Data type	Description
105 (69 H)	Broadcast Limit	Get/Set	UDINT	Broadcast limiter Service (Egress BC-Frames limitation, 0: disabled), Frames/second
106 (6A H)	Ethernet Interface Description	Get	STRING [max. 64 Bytes] even number of Bytes	Interface/Port Description (from MIB II ifDescr), e.g. "Unit: 1 Slot: 2 Port: 1 - 10/100 Mbit TX", or "unavailable", max. 64 Bytes.

*Table 6: Hirschmann-Erweiterungen des Ethernet Link-Objekts*

- a. Einheit: 1 Hundertstel von 1%, d.h., 100 entspricht 1%



## 2.2.4 Ethernet Switch Agent Object

The Switch supports the Hirschmann vendor specific Ethernet Switch Agent Object (Class Code 95<sub>H</sub>, 149) for the Switch configuration and information parameters with one instance (Instance 1).

For further information on these parameters and how to adjust them refer to the Reference Manual „GUI“ (Graphical User Interface / Web-based Interface).

Attribute	ID/Bit No.	Description
Switch Status	ID 01	DWORD (32 bit) RO
	Bit 0	Overall state (0: ok, 1: failed) Like the signal contact.
	Bit 1	Power Supply 1 (0: ok, 1: failed or does not exist)
	Bit 2	Power Supply 2 (0: ok, 1: failed or does not exist)
	Bit 3	Power Supply 3 (0: ok or not possible on this platform, 1: failed or does not exist)
	Bit 4	Power Supply 4 (0: ok or not possible on this platform, 1: failed or does not exist)
	Bit 5	Power Supply 5 (0: ok or not possible on this platform, 1: failed or does not exist)
	Bit 6	Power Supply 6 (0: ok or not possible on this platform, 1: failed or does not exist)
	Bit 7	Power Supply 7 (0: ok or not possible on this platform, 1: failed or does not exist)
	Bit 8	Power Supply 8 (0: ok or not possible on this platform, 1: failed or does not exist)
	Bit 9	DIP RM (ON: 1, OFF: 0)
	Bit 10	DIP Standby (ON: 1, OFF: 0)
	Bit 11	Signal Contact 1 (0: closed, 1: open)
	Bit 12	Signal Contact 2 (0: closed, 1: open)
	Bit 13	Quick Connect (1: ON, 0: OFF)
	Bit 16	Temperature (0: ok, 1: threshold exceeded)
	Bit 17	Fan (0: ok or no fan, 1: inoperable)
	Bit 21	DIP Ring ports, 0: module 1 ports 1&2, 1: module 2, ports 1&2
	Bit 22	DIP Configuration (1: enabled, 0: disabled)
	Bit 23	DIP HIPER-Ring state (1: ON, 0: OFF)
	Bit 24	Module removed (1: removed)
	Bit 25	ACA removed (1: removed)
	Bit 28	Hiper-Ring (1: loss of redundancy reserve)
	Bit 29	Ring-/Netcoupling (1: loss of redundancy reserve)

*Table 7: Hirschmann Ethernet Switch Agent Object*

Attribute	ID/Bit No.	Description
	Bit 30	Connection Error (1: link inoperable)
Switch Temperature	ID 02	Struct{INT RO Temperature °F, INT RO Temperature °C}
Reserved	ID 03	Always 0, attribute is reserved for future use.
Switch Max Ports	ID 04	UINT (16 bit) RO Maximum number of Ethernet Switch Ports
Multicast Settings (IGMP Snooping)	ID 05	WORD (16 bit) RW
	Bit 0 RW	IGMP Snooping (1: enabled, 0: disabled)
	Bit 1 RW	IGMP Querier (1: enabled, 0: disabled)
	Bit 2 RO	IGMP Querier Mode (1: Querier, 0: Non-Querier)
	Bit 4-6 RW	IGMP Querier Packet Version 1: V1, 2: V2, 3: V3, 0: Off (IGMP Querier disabled)
	Bit 8-10 RW	Treatment of Unknown Multicasts (Railswitch only): 0: Send To All Ports, 1: Send To Query Ports, 2: Discard
Switch Existing Ports	ID 06	ARRAY OF DWORD <sup>a</sup> RO Bitmask of existing Switch Ports
	Per Bit starting with Bit 0 (means Port 1)	1: Port existing, 0: Port not available. Array (bit mask) size is adjusted to the size of maximum number of Switch ports (e.g. a max. no of 28 ports means that 1 DWORD is used (32 bit)).
Switch Port Control	ID 07	ARRAY OF DWORD <sup>a</sup> RW Bitmask Link Admin Status Switch Ports
	Per Bit starting with Bit 0 (means Port 1)	0: Port enabled, 1: Port disabled. Array (bit mask) size is adjusted to the size of maximum number of Switch ports (e.g. a max. no of 28 ports means that 1 DWORD is used (32 bit)).
Switch Ports Mapping	ID 08	ARRAY OF USINT (BYTE, 8 bit) RO Instance number of the Ethernet Link Object
	Starting with Index 0 (means Port 1)	All Ethernet Link Object Instances for the existing Ethernet Switch Ports (1..N (maximum number of ports)). When the entry is 0, the Ethernet Link Object for this port does not exist.
Switch Action Status	ID 09	DWORD (32 bit) RO
	Bit 0	Flash write in progress
	Bit 1	Unable to write to flash or write incomplete

*Table 7: Hirschmann Ethernet Switch Agent Object*

- a. RS20/RS30/RS40, MS20/MS30, OCTOPUS, PowerMICE, RSR20/RSR30, MACH 100 and MACH 1000: 32 bit;  
MACH 4000: 64 bit

The Hirschmann specific Ethernet Switch Agent Object provides you with the additional vendor specific service, with the Service-Code 35<sub>H</sub> for saving the Switch configuration. The Switch replies to the request for saving the configuration, as soon as it saved the configuration in the flash memory.

## 2.2.5 RSTP Bridge Object

Id	Attribute	Access rule	Data type	Description
1	Bridge Identifier Priority	Set	UDINT	Range: 0 to 61,440 in steps of 4,096, default: 32,768 (refer to IEEE, 802.1D-2004, § 17.13.7)
2	Transmit Hold Count	Set	UINT	Range: 1 to 40, default: 10 (refer to IEEE 802.1D-2004, §17.13.12)
3	Force Protocol Version	Set	UINT	Default:2 (refer to IEEE 802.1D-2004, §17.13.4 and dot1dStpVersion in RFC 4318)
4	Bridge Hello Time	Set	UDINT	Range: 100 to 200, unit: centi-seconds (1/100 of a second), default: 200 (refer to IEEE 802.1D-2004, §17.13.6 and dot1dStpHoldTime in RFC 4188)
5	Bridge Forward Delay	Set	UDINT	Range: 400 to 3000, unit: centi-seconds, default: 2100 (refer to IEEE 802.1D-2004, §17.13.5 and dot1dStpForwardDelay in RFC 4188)
6	Bridge Max. Age	Set	UINT	Range: 600 to 4000, unit: centi-seconds, default: 4000 (refer to IEEE 802.1D-2004, §17.13.8 and dot1dStpBridgeMaxAge in RFC 4188)
7	Time Since Topology Change	Get	UDINT	Unit: centi-seconds (refer to dot1dStpTimeSinceTopologyChange in RFC 4188)
8	Topology Change	Get	UDINT	Refer to dot1dStpTopChanges in RFC 4188
100	InnerPort	Get	UINT	Hirschmann-specific object. ▶ For instance 1, it holds the port number of the DRSTP Primary instance's inner port. ▶ For instance 2, it holds the port number of the DRSTP Secondary instance's inner port.
101	OuterPort	Get	UINT	Hirschmann-specific object. ▶ For instance 1, it holds the port number of the DRSTP Primary instance's outer port. ▶ For instance 2, it holds the port number of the DRSTP Secondary instance's outer port.

Table 8: *Hirschmann RSTP Bridge Object*

## 2.2.6 RSTP Port Object

<b>Id</b>	<b>Attribute</b>	<b>Access rule</b>	<b>Data type</b>	<b>Description</b>
1	Port Identifier Priority	Set	UDINT	Range: 0 to 240 in steps of 16, default: 128 (refer to IEEE, 802.1D-2004, § 17.13.10).
2	mcheck	Set	BOOL	True (1), False (2) (refer to IEEE 802.1D-2004, §17.19.13 and dot1dStpPortProtocolMigration in RFC 4318).
3	Port Path Cost	Set	UDINT	Range: 1 to 200,00,000, default:auto (0) (refer to IEEE 802.1D-2004, §17.13.11 and dot1dStpPortAdminPathCost in RFC 4318).
4	Port Admin Edge Port	Set	BOOL	True (1), False (2) (refer to IEEE 802.1D-2004, §17.13.1 and dot1dStpPortAdminEdgePort in RFC 4318).
5	Port Oper Edge Port	Get	BOOL	True (1), False (2) (refer to dot1dStpPortOperEdgePort in RFC 4318).
6	Port Admin PointToPoint	Set	UINT	forceTrue (0), forceFalse (1), auto (2) (refer to dot1dStpPortAdminPointToPoint in RFC 4318).
7	Port Oper PointToPoint	Get	UINT	True (1), False (2) (refer to dot1dStpPortOperPointToPoint in RFC 4318).
8	Port Enable	Set	UINT	Enabled (1), Disabled (2) (Refer to dot1dStpPortEnable in RFC 4188).
9	Port State	Get	UINT	Disabled (1), Blocking (2), Listening (3), Learning (4), Forwarding (5), Broken (6) (refer to dot1dStpPortState in RFC 4188).
10	Port Role	Get	UNT	Unknown (0), Alternate/Backup (1), Root (2), Designated (3) (refer to dot1dStpTopChanges in RFC 4188).
100	DRSTP	Get	UINT	Hirschmann-specific object. True (1), False (2).

Table 9: Hirschmann RSTP Port Object

## 2.2.7 I/O Data

You will find the exact meaning of the individual bits of the device status in the I/O data in [“Ethernet Switch Agent Object” on page 25](#).

I/O Data	Value (data types and sizes to be defined)	Direction
Device Status	Bitmask (see Switch Agent Attribute 1)	Input, DWORD 32 Bit
Link Status	Bitmask, 1 Bit per port 0: No link, 1: Link up	Input, DWORD <sup>a</sup>
Output Links Admin State applied	Bitmask (1 Bit per port) to acknowledge output. Link state change can be denied, e.g. for controller access port. 0: Port enabled, 1: Port disabled.	Input DWORD <sup>a</sup>
Utilization Alarm	Bitmask, 1 Bit per port 0: No alarm, 1: Alarm on port	Input, DWORD <sup>a</sup>
Access Violation Alarm	Bitmask, 1 Bit per port 0: No alarm, 1: Alarm on port	Input, DWORD <sup>a</sup>
Multicast Connections	Integer, number of connections	Input, 1 DINT 32 bit
TCP/IP Connections	Integer, number of connections	Input, 1 DINT 32 bit
Link Admin State	Bitmask, one bit per port 0: Port enabled, 1: Port disabled	Output, DWORD <sup>a</sup>

*Table 10: I/O Data*

- a. RS20/RS30/RS40, MS20/MS30, OCTOPUS, PowerMICE, RSR20/RSR30, MACH 100 and MACH 1000: 32 Bit;  
MACH 4000: 64 Bit

### 2.2.8 Assignment of the Ethernet Link Object Instances

The table shows the assignment of the Switch ports to the Ethernet Link Object Instances.

<b>Ethernet Link Object Instance</b>	<b>RS20/RS30/RS40 RSR20/RSR30, OCTOPUS, MACH 1000</b>	<b>MS20/MS30, PowerMICE, MACH 100</b>	<b>MACH 4000</b>
1	CPU	CPU	CPU
2	1	Module 1 / port 1	Module 1 / port 1
3	2	Module 1 / port 2	Module 1 / port 2
4	3	Module 1 / port 3	Module 1 / port 3
5	4	Module 1 / port 4	Module 1 / port 4
6	5	Module 2 / port 1	Module 1 / port 5
7	6	Module 2 / port 2	Module 1 / port 6
8	7	Module 2 / port 3	Module 1 / port 7
9	8	Module 2 / port 4	Module 1 / port 8
10	9	Module 3 / port 1	Module 2 / port 1
11	10	Module 3 / port 2	Module 2 / port 2
12	11	Module 3 / port 3	Module 2 / port 3
13	12	Module 3 / port 4	Module 2 / port 4
14	13	Module 4 / port 1	Module 2 / port 5
..	..	..	..

*Table 11: Assignment of the Switch ports to the Ethernet Link Object Instances*

## 2.2.9 Supported Services

The table gives you an overview of the services for the object instances supported by the EtherNet/IP implementation.

Service code	Identity Object	TCP/IP Interface Object	Ethernet Link Object	Switch Agent Object
Get Attribute All (01H)	All Attributes	All Attributes	All Attributes	All Attributes
Set Attribute All (02H)	-	Settable Attributes (3, 5, 6)	-	-
Get Attribute Single (0EH)	All Attributes	All Attributes	All Attributes	All Attributes
Set Attribute Single (10H)	-	Settable Attributes (3, 5, 6)	Settable Attributes (6, 65H, 67H, 68H, 69H)	Settable Attributes (7)
Reset (05H)	Parameter (0.1)	-	-	-
Save Configuration (35H) Vendor-specific	Parameter (0.1)	-	-	Save Switch Configuration

*Table 12: Supported Services*



### 3 PROFINET IO

PROFINET IO is an industrial communication network based on Ethernet that is accepted worldwide. It is based on the widely used transport protocols TCP/IP and UDP/IP (standard). This is an important aspect for fulfilling the requirements for consistency from the management level down to the field level.

PROFINET IO enhances the existing Profibus technology for such applications that require fast data communication and the use of industrial IT functions.

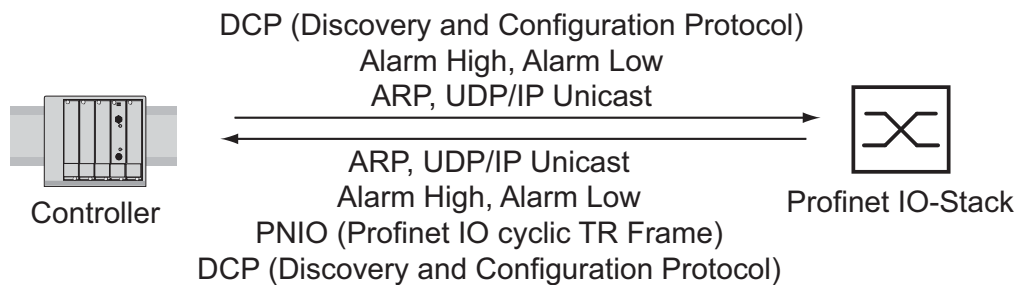

Figure 6: Communication between the Controller and the Switch

In particular, you will find PROFINET IO in Europe and in conjunction with Siemens controllers.

PROFINET IO uses the device description language GSDML (Generic Station Description Markup Language) to describe devices and their properties so that they can be processed automatically. You will find the device description in the GSD(ML) file of the device.

You will find detailed information on PROFINET on the Internet site of the PROFIBUS Organization at <http://www.profibus.com>. The devices conform to class B for PROFINET IO.

■ Switch Models for PROFINET IO GSDML Version 1.0

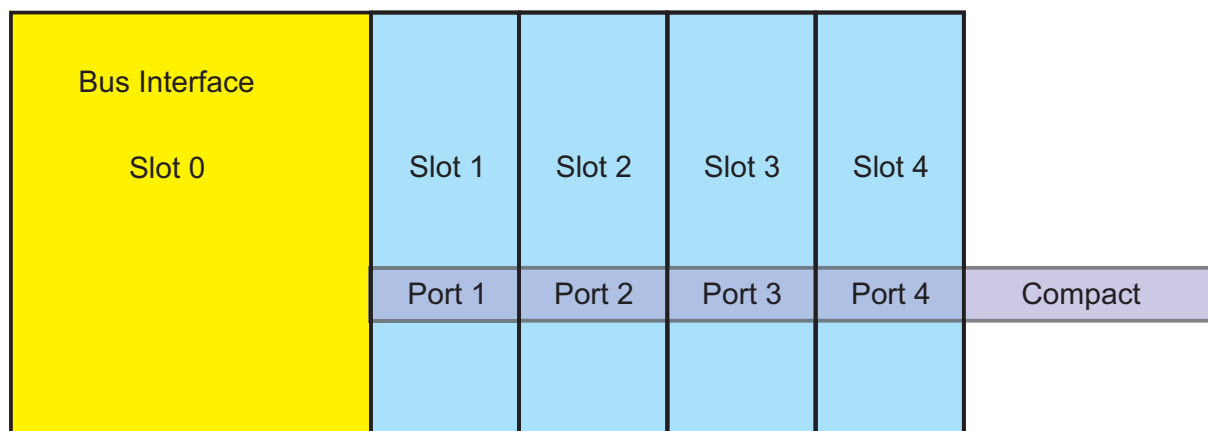

Figure 7: Compact Switch

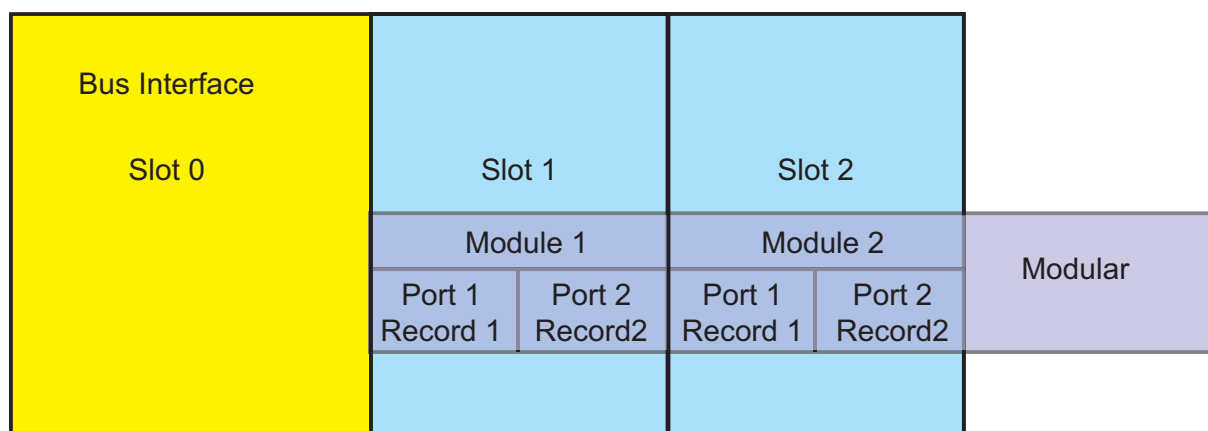

Figure 8: Modular Switch

■ Switch Models for PROFINET IO GSDML Version 2.0

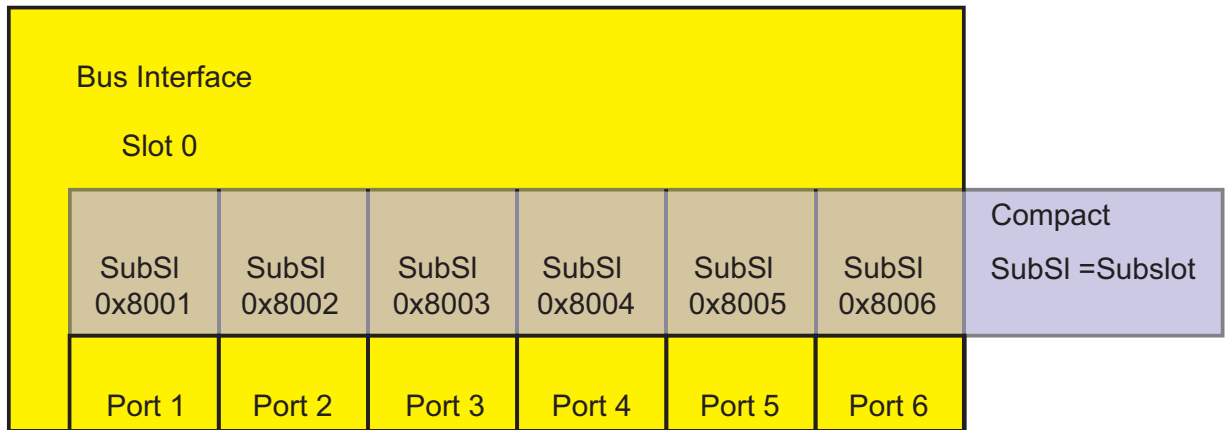

Figure 9: Compact Switch

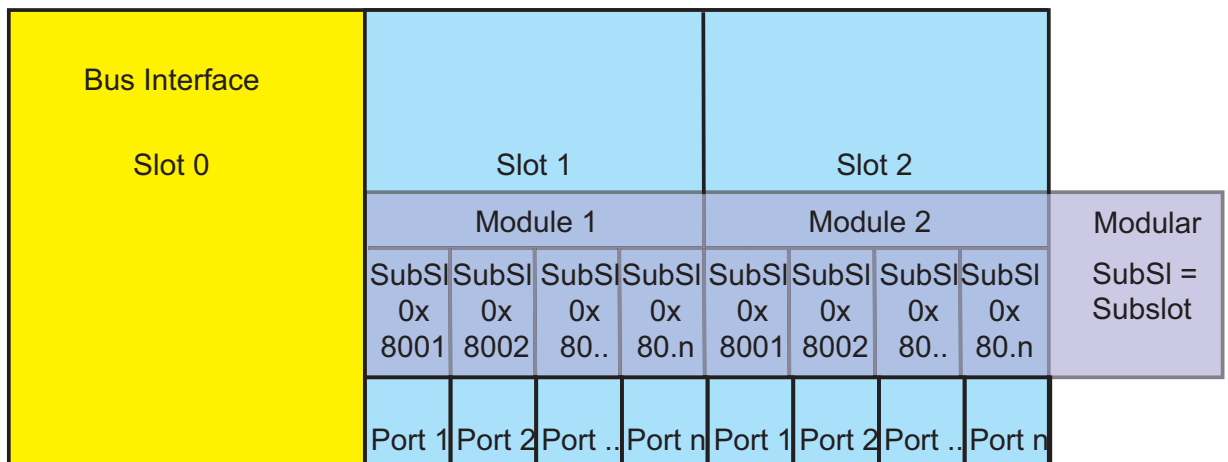

Figure 10: Modular Switch

## 3.1 Integration into a Control System

### 3.1.1 Preparing the Switch

After installing and connecting the Switch, you configure it according to the “Basic Configuration” user manual:

- Use the Web-based interface in the `Basic Settings:Network` dialog to check whether `Local` is selected in the “Mode” frame.
- Use the Web-based interface in the `Switching:VLAN:Global` dialog to check whether “VLAN 0 Transparent Mode” is selected.
- Use the Web-based interface in the `Advanced:Industry Protocols:PROFINET IO` dialog to check whether Profinet IO is activated.
- Load the GSD(ML) file and the icon onto your local computer.  
You get the GSD(ML) file and the icon
  - by using the Web-based interface in the `Advanced:Industry Protocols` dialog or
  - by using the software (Stand Alone GSDML File Generator) for creating the GSD(ML) file, which is included in the delivery.
- Configure the alarm setting and the threshold value for the alarms you want to monitor.

### 3.1.2 Configuration of the PLC

The following illustrates the configuration of the PLC using the example of the Simatic S7 software from Siemens, and assumes that you are familiar with operating the software.

The device also supports engineering stations from other manufacturers, such as PC Worx from Phönix.

**Note:** If for example, a management program is occupying the Switch CPU with SNMP requests, the I/O connection between the programmable logic controller (PLC) and the Switch can be interrupted for a time. As the Switch can still transmit data packages in this case, the system can also still be ready for operation.

The monitoring of the I/O connection to the Switch CPU as a failure criterion can result in system failure and is therefore less suitable as a failure criterion.

In the PLC default setting, the PLC sees the interruption of the I/O connection to the Switch as a failure criterion. According to the default setting, this leads to a system failure. To change this default setting, you employ Step7 programming measures.

#### ■ Providing the GDSML file

The Hirschmann provides you with the following options for generating GDSML files and icons:

- ▶ you can use the Web-based interface in the `Advanced:Industry Protocols:PROFINET IO` dialog to select `PROFINET IO` and download the GSDML file and the icon of the device.
- ▶ you can use the Web-based interface in the `Advanced:Industry Protocols:PROFINET IO` dialog to select `Other device` and download the GSDML file and the icon of another device, for which you enter the order description.
- ▶ you can use the software included in the delivery (Stand Alone GSDML File Generator) to create the GSDML file.

- Incorporating the Switch in the configuration
  - Open the “Simatic Manager” from Simatic S7.
  - Open your project.
  - Go to the hardware configuration.
  - Install the GSD(ML) file using `Extras:Install GSD File`.  
Select the GSD file previously saved on your PC.  
Simatic S7 installs the file together with the icon.  
You will find the new Switch under `Profinet IO:Other Field Devices:Switching Devices:Hirschmann..` or under `Profinet IO:Other Field Devices:Network Components:Hirschmann...`
  - Use Drag & Drop to pull the Switch onto the bus cable.

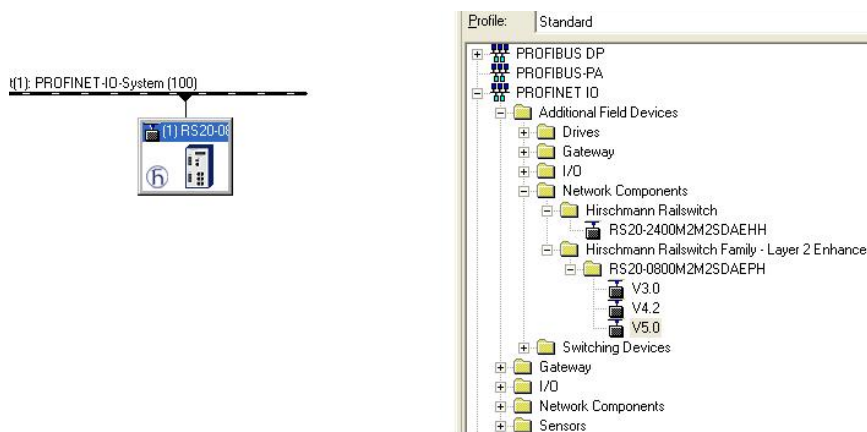

Figure 11: Adding a Switch from the Simatic S7 library

- To give the Switch its name, select the Switch and in the menu bar choose Target System:Ethernet>Edit Ethernet Participants...

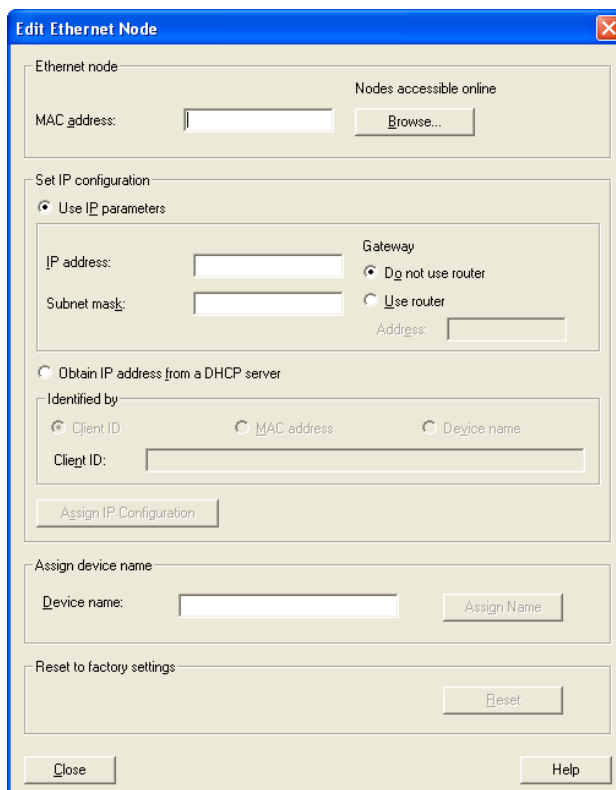

Figure 12: Dialog for entering the Switch name

- Click on "Browse".  
Select your Switch.  
Click on "OK".

- Give the Switch its name.  
Click on “Assign Name”.
- Click on “Close”.
  
- In the hardware configuration, right-click on the Switch and select Object properties.

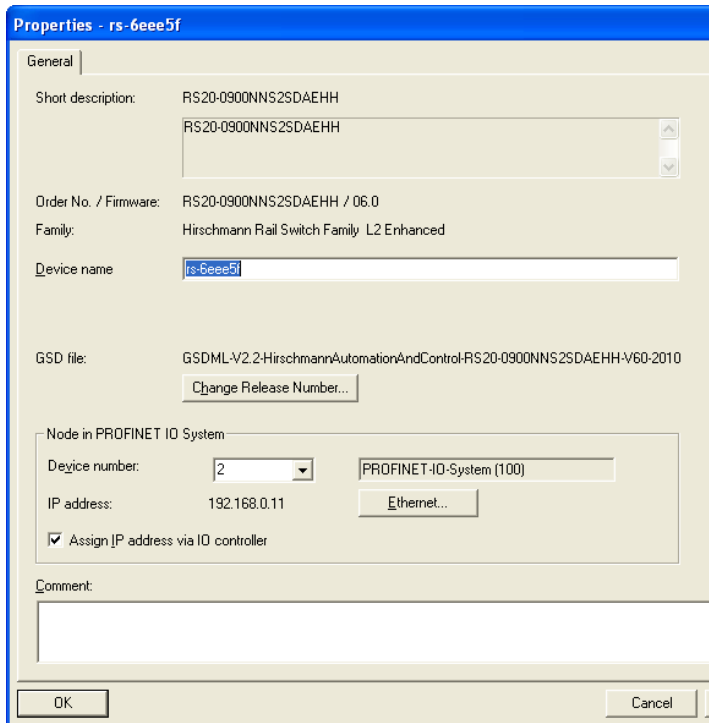

Figure 13: Dialog for entering the object name (= name of the Switch) and the IP parameter

- Enter the same device name here.
- Click on “Ethernet”.  
Enter the IP parameters.  
Close the Ethernet input window.
- Click on “OK” to close the properties window.

The Switch is now included in the configuration.



## Configuring IO Cycle

- In the hardware configuration, right-click on the Switch and select Object properties.

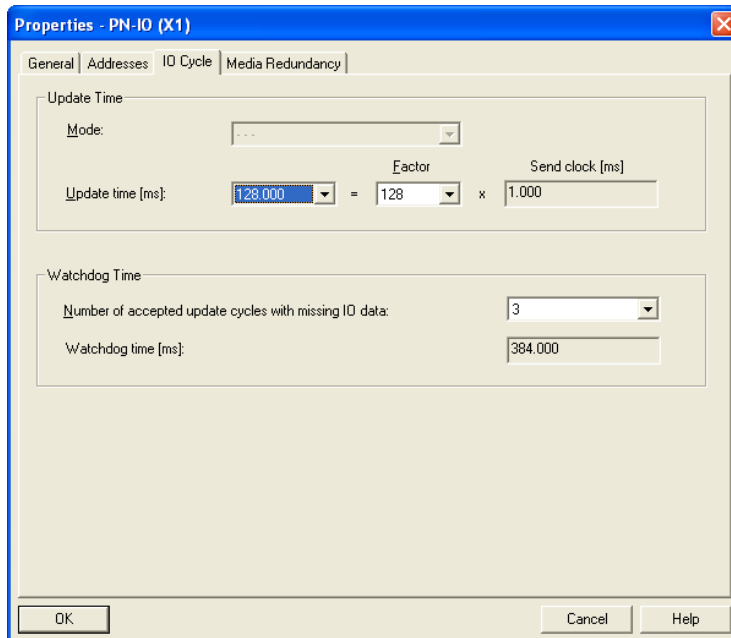

Figure 14: Dialog for entering the IO Cycle

- In the Properties window, select the “IO Cycle” tab.
- Under Update Time/Update time[ms]:, select the required update time (in ms) for the IO Cycle (see figure 14).
- Under Watchdog Time/Number of accepted update cycles with missing IO data, select the required number for the IO Cycle (see figure 14).
- Click on “OK” to close the properties window.

## Configuring Media Redundancy

- In the hardware configuration, right-click on the Switch and select Object properties.

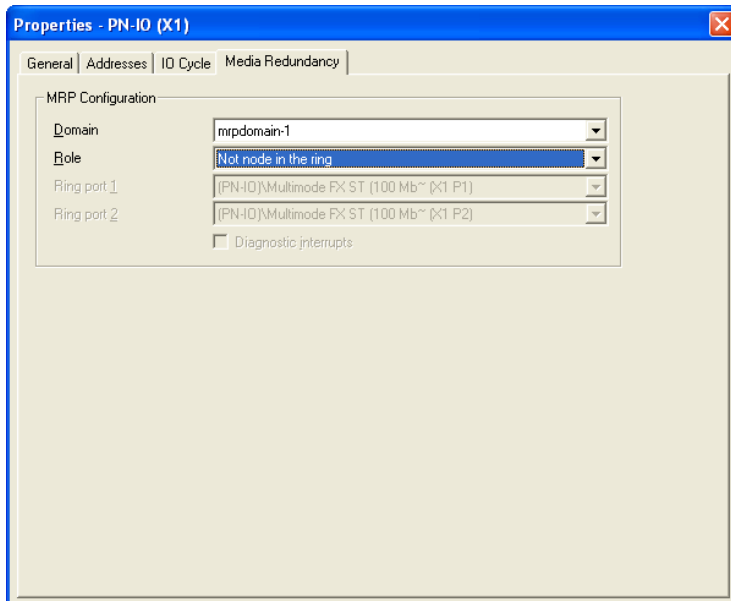

Figure 15: Dialog for entering the Media redundancy

- In the Properties window, select the “Media Redundancy” tab.
  - Under MRP Configuration/Domain , select the required MRP domain for the node (see figure 15).
  - Under MRP Configuration/Role , select the required role of the node in the ring (see figure 15).
  - Under Ring Port 1/2 , select the active MRP Ring Ports.
  - Click on “OK” to close the properties window.
- Adding modules for modular devices
- Use Drag & Drop to pull a module from the library into a slot. Simatic S7 adds the ports using the Module properties.

- Configuring device property
  - On slot 0 you enter the settings for the entire Switch.
  - Select the Switch.
  - Right-click on slot 0.
    - To configure the entire device, select Object properties.
  - In the Properties window, select the “Parameters” tab.

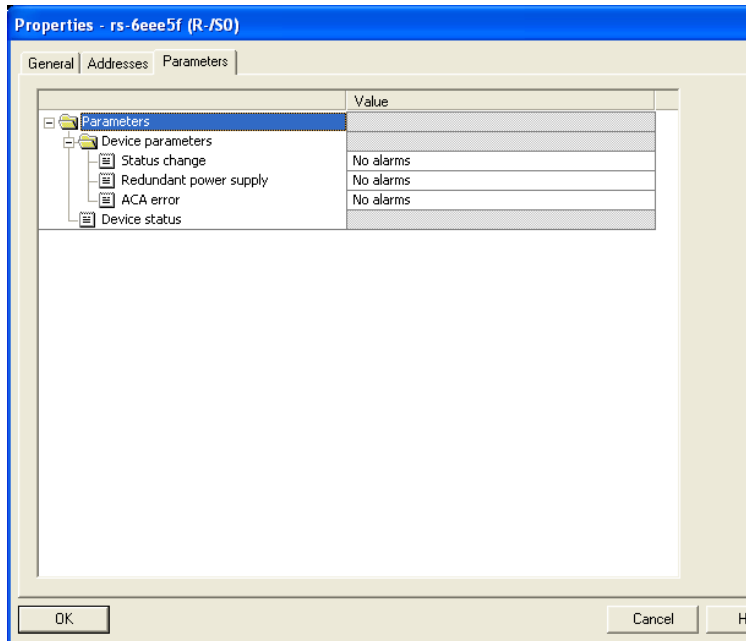

Figure 16: Configuring device alarms for e.g. RS20/RS30.

### ■ Configuring the port properties

For modular devices, slots 1 to n represent the modules. Within the slots, the ports are shown as records.

For non-modular devices, the slots 1 to n represent the ports.

### Configuring Alarms

- Right-click on one of the slots 1 to n and select `Object properties`.
- In the Properties window, select the “Parameters” tab.
- Select the desired alarms and close the window (see figure 17).

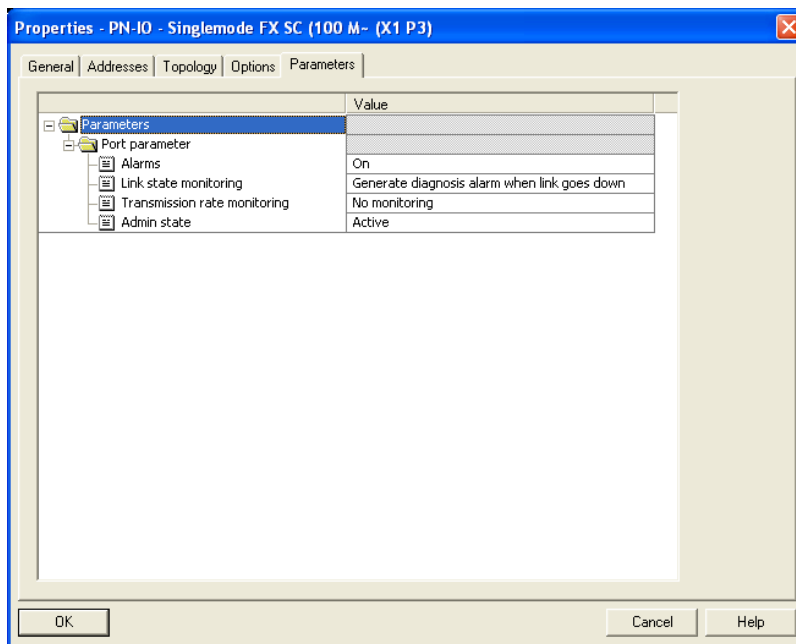

Figure 17: Port properties

#### Special case: “LinkDown” alarm:

The LinkDown alarm is made up of the AND-link

- of the Hirschmann-specific status for connection errors and
- of the Simatic S7-specific option for the connection.

Activating the LinkDown alarm:

- Under `Object properties`, select the `Parameter` tab (Hirschmann-specific).  
Activate “Alarms” and select the option `Generate diagnosis alarm when link goes down` under “Link state monitoring”.
- Under `Object properties`, select the `Options` tab (Simatic S7-specific).  
To activate the link monitoring, select a fixed setting for the port under `Connection/Transmission medium/Duplex`.

### ■ Configuring Connection Options

- Right-click on one of the slots 1 to n and select `Object properties`.

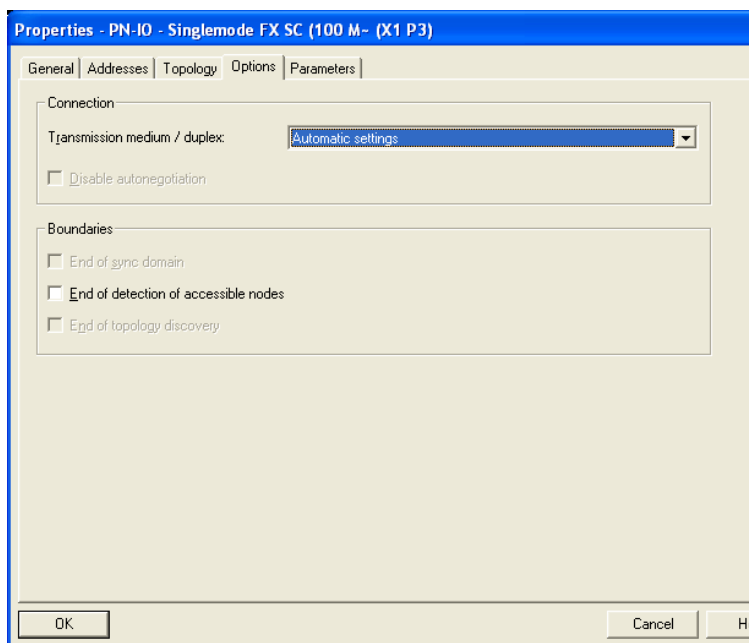

Figure 18: Dialog for entering the connection options

- In the Properties window, select the "Options" tab.
- Under `Connection/Transmission medium/duplex`, select the required setting for the port (see figure 18).
- Click on "OK" to close the properties window.

## Configuring Topology

- Right-click on one of the slots 1 to n and select `Object properties`.

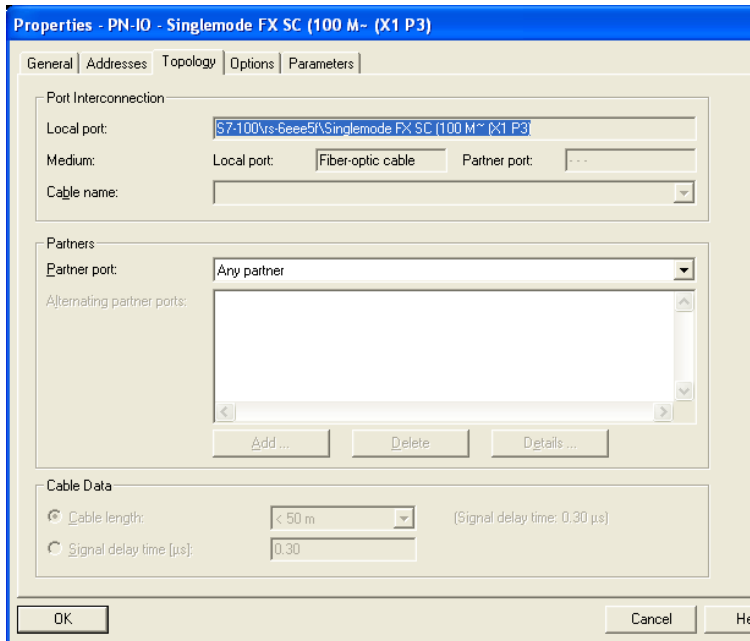

Figure 19: Dialog for entering the topology

- In the Properties window, select the "Topology" tab.
- Under `Port Interconnection/Local port`, select the required setting for the port (see figure 19).
- Under `Partner/Partner port`, select the required setting for the partner port (see figure 19).
- Click on "OK" to close the properties window.

### 3.1.3 Configuring the device

Included with the device is the program “Hirschmann Tool Calling Interface”, which you can install with the installation program

HirschmannToolCallingInterfaceXXXXXSetup.exe (XXXXX = software version, e.g. 01000).

After installing the program “Hirschmann Tool Calling Interface”, you have the option of starting two Hirschmann operating programs in Simatic S7 in order to perform more detailed device configurations.

- In Simatic S7, right-click on a device and select Web-based Interface (WWW) or Telnet in the drop-down menu.

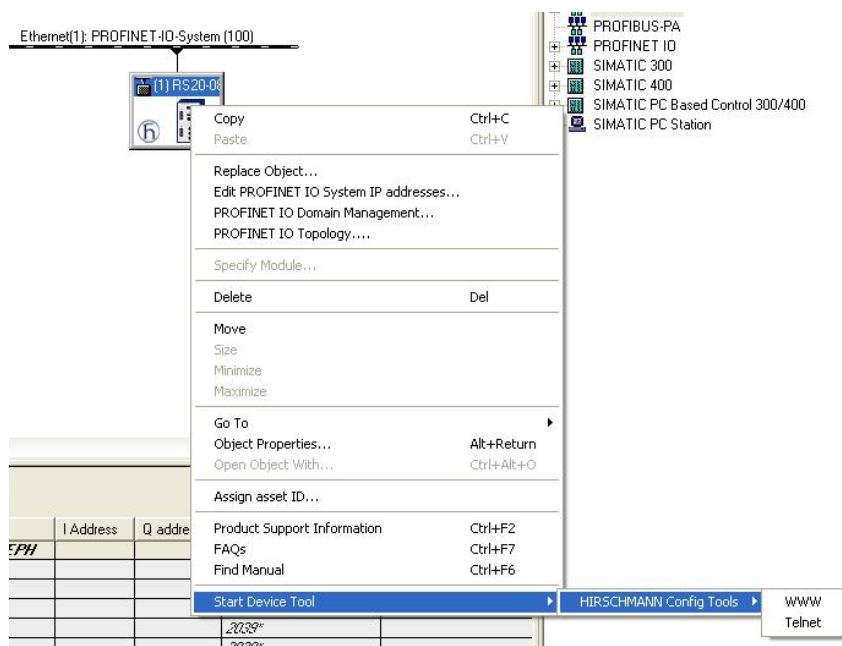

Figure 20: Call up the Hirschmann operating program

### 3.1.4 Swapping devices

Hirschmann devices support the device swapping function with an engineering station.

If identical devices are being swapped, the engineering station assigns the parameters of the original device to the new device.

The device swapping function with Simatic S7 requires the following prerequisites:

- ▶ S7 300 with SW release from V2.7 (currently available for CPU 319) or S7 400 with SW release from V5.2
- ▶ Hirschmann device SW release from 05.0.00
- ▶ Neighboring device(s) support(s) LLDP
- ▶ Topology (=neighborhood relationships) is configured and loaded onto SPS

Device swapping requires the following conditions:

- ▶ the replacement device is of exactly the same type as the device to be replaced.
- ▶ the replacement device is connected to exactly the same place in the network (same ports and neighboring devices).
- ▶ the replacement device has a Profinet default configuration. Set the device name to "" (null string).

If all these conditions are fulfilled, the engineering station automatically assigns the parameters of the original device (device name, IP parameters and configuration data) to the replacement device.

Procedure for swapping devices:

- Reset the replacement device to the state on delivery:
  - System name "" (= null string)
  - IP address = 0.0.0.0 or DHCP
  - PROFINET IO activated
- Make a note of the port assignment of the original device and remove the original device from the system.  
The PLC now detects an error.
- Now insert the replacement device at the same position in the network.  
Make sure the port assignments are the same as for the original device.  
The PLC finds the replacement device and configures it like the original device.

The PLC detects normal operation again.

If necessary, reset the PLC to "Run".



### 3.1.5 Swapping modules

The PROFINET IO stack in the device detects a change in the modules connected and reports the change to the engineering station. If a previously configured module is removed from the device, the engineering station reports an error. If a configured module that was missing is connected, the engineering station removes the error message.

### 3.1.6 Monitoring the network

#### ■ Topology Discovery

After the user initializes the Topology Discovery, the engineering station looks for connected devices.

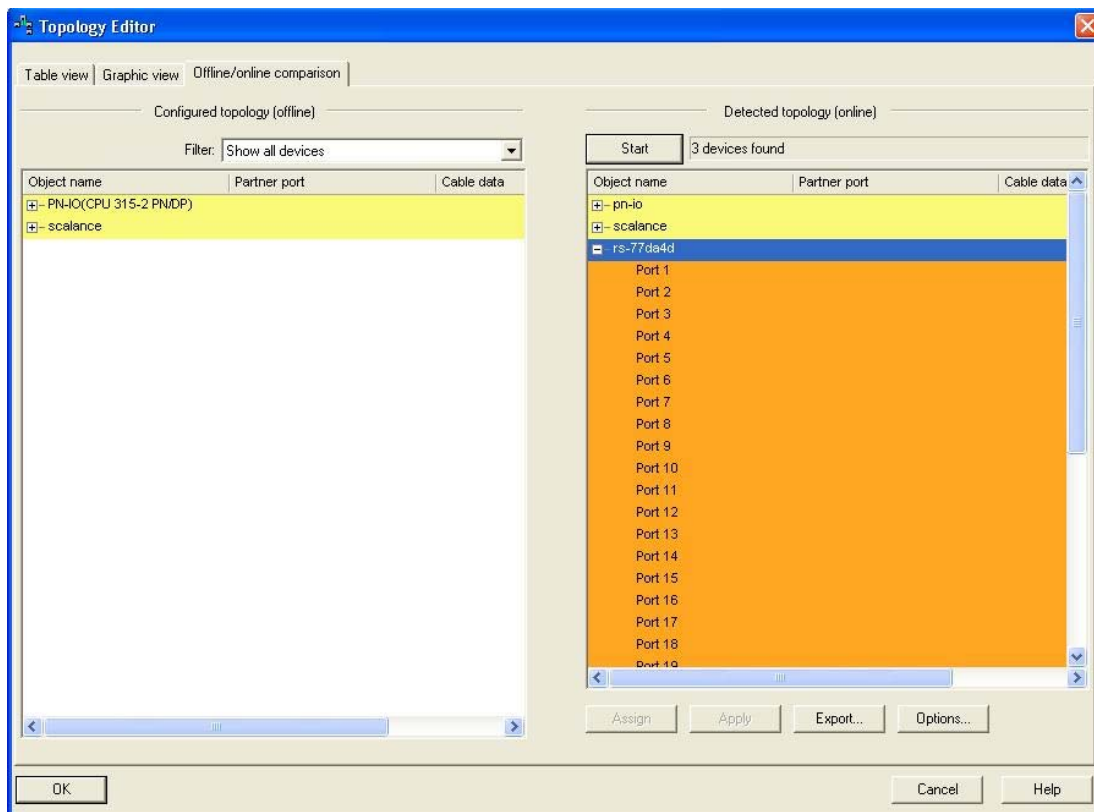

Figure 21: Topology Discovery

- Configuring the topology  
Simatic S7 gives the user the option to configure the topology and monitor it accordingly.  
Simatic S7 displays the connection parameters (quality and settings) in a colored graphic.

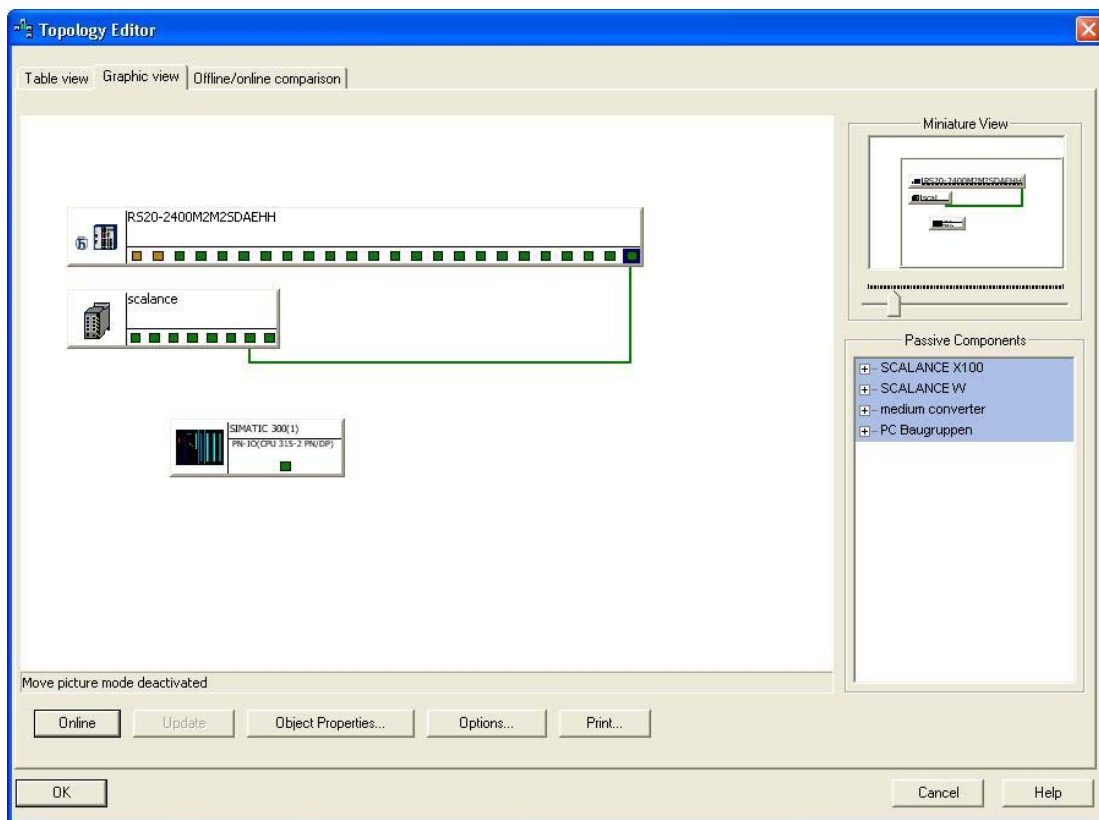

Figure 22: Configuring the topology

- Communication diagnosis  
Simatic S7 monitors the communication quality and outputs messages relating to communication problems.

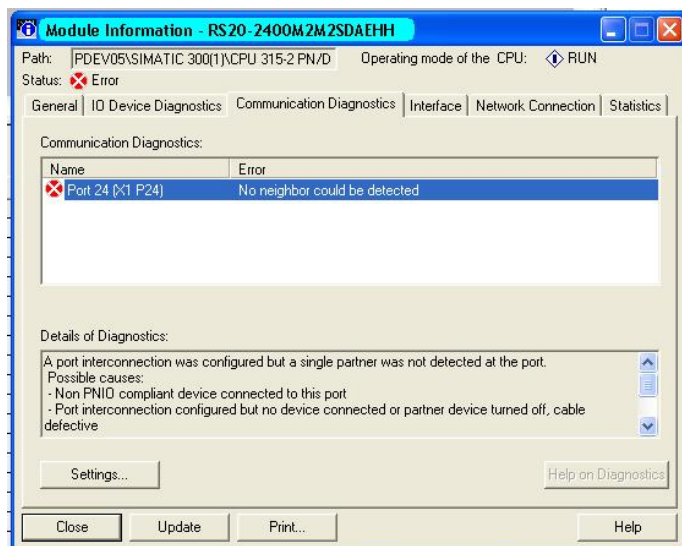
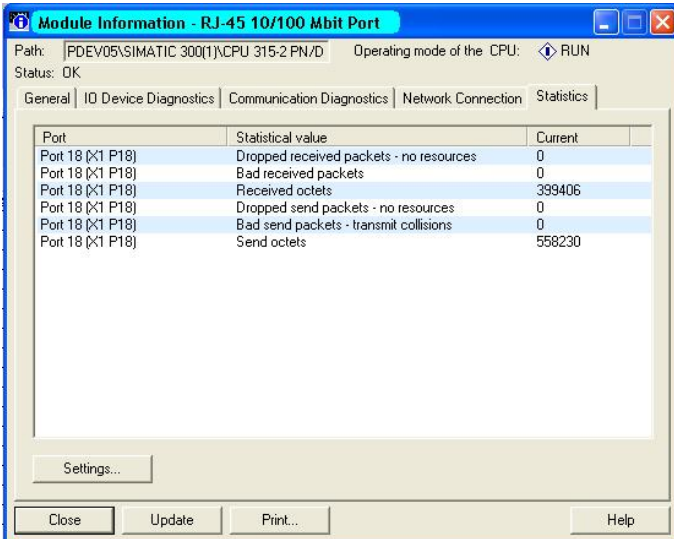

Figure 23: Diagnosis messages for the communication between the Switches and IO devices

### ■ Outputting port statistics

Simatic S7 counts for each port the number of data packets received and sent, the collisions, etc. You can view these figures in the form of statistic tables in Simatic S7.



The screenshot shows a window titled "Module Information - RJ-45 10/100 Mbit Port". The window displays the path "PDEV05\SIMATIC 300(1)\CPU 315-2 PN/D" and the operating mode of the CPU as "RUN". The status is "OK". The window has several tabs: "General", "IO Device Diagnostics", "Communication Diagnostics", "Network Connection", and "Statistics". The "Statistics" tab is active, showing a table of port statistics for "Port 18 (x1 P18)".

Port	Statistical value	Current
Port 18 (x1 P18)	Dropped received packets - no resources	0
Port 18 (x1 P18)	Bad received packets	0
Port 18 (x1 P18)	Received octets	399406
Port 18 (x1 P18)	Dropped send packets - no resources	0
Port 18 (x1 P18)	Bad send packets - transmit collisions	0
Port 18 (x1 P18)	Send octets	558230

At the bottom of the window, there are buttons for "Settings...", "Close", "Update", "Print...", and "Help".

Figure 24: Example of a port statistic table

## 3.2 PROFINET IO Parameters

### 3.2.1 Alarms

The Switch supports alarms on the device and port levels (see „Device State“ in the Basic Configuration User Manual or the Web-based Interface Reference Manual).

Alarms on device level	Change in device status - Failure of redundant power supply - Failure/removal of ACA
Alarms on port level	- Change in link status - Specified transfer rate exceeded.

*Table 13: Alarms supported*

### 3.2.2 Record parameters

The Switch provides records for:

- ▶ Device parameters
- ▶ Device status
- ▶ Port status/parameters

Byte	Content	Access	Value	Meaning
0	Send alarm if status changes	rw	0	Do not send alarms
			1	Send alarm if one of the following alarm reasons occurs.
1	Power Alarm	rw	0	Do not send alarm
			1	Send alarm if a power supply fails.
2	ACA Alarm	rw	0	Do not send alarm
			1	Send alarm if the ACA is removed.
3	Module Alarm	rw	0	Do not send alarm
			1	Send alarm if the module connections are changed.

Table 14: Device parameters

Byte	Content	Access	Value	Meaning
0	Device Status	ro	0	Unavailable
			1	OK
			2	Error
1	Power supply unit 1	ro	0	Unavailable
			1	OK
			2	Error
2	Power supply unit 2	ro	0	Unavailable
			1	OK
			2	Error
3	Power supply unit 3	ro	0	Unavailable
			1	OK
			2	Error
4	Power supply unit 4	ro	0	Unavailable
			1	OK
			2	Error
5	Power supply unit 5	ro	0	Unavailable
			1	OK
			2	Error
6	Power supply unit 6	ro	0	Unavailable
			1	OK
			2	Error
7	Power supply unit 7	ro	0	Unavailable
			1	OK
			2	Error

Table 15: Device status

Byte	Content	Access	Value	Meaning
8	Power supply unit 8	ro	0	Unavailable
			1	OK
			2	Error
9	Signal contact 1	ro	0	Unavailable
			1	Closed
			2	Open
10	Signal contact 2	ro	0	Unavailable
			1	Closed
			2	Open
11	Temperature	ro	0	Unavailable
			1	OK
			2	Threshold value for temperature exceeded or not reached
12	Fan	ro	0	Unavailable
			1	OK
			2	Fan failure
13	Module removal	ro	0	Unavailable
			1	OK
			2	A module has been removed.
14	ACA removal	ro	0	Unavailable
			1	OK
			2	The ACA has been removed.
15	HIPER_Ring	ro	0	Unavailable
			1	OK
			2	Redundancy failure.
16	Ring/Network coupling	ro	0	Unavailable
			1	OK
			2	Redundancy failure.
17	Connection	ro	0	Unavailable
			1	OK
			2	Connection failure.

Table 15: Device status

Byte	Content	Access	Value	Meaning
0	Report port error	rw	0	Do not send alarms
			1	Send alarm if one of the following alarm reasons occurs.

Table 16: Port status/parameters



Byte	Content	Access	Value	Meaning
1	Report connection error	rw	0	Do not send alarm
			1	Send alarm if the connection has failed.
2	Transmission rate too high	rw	0	Do not send alarm
			1	Send alarm if the threshold value for the temperature has been exceeded.
3	Port on	rw	0	Unavailable
			1	Switched on
			2	Switched off
4	Link status	ro	0	Unavailable
			1	Connection exists
			2	Connection interrupted
5	Bit rate	ro	0	Unavailable
			1	Unknown
			2	10 MBit/s
			2	100 MBit/s
6	Duplex	ro	0	Unavailable
			1	Half duplex
			2	Full duplex
			2	1000 MBit/s
7	Autonegotiation	ro	0	Unavailable
			1	Off
			2	On

*Table 16: Port status/parameters*

### 3.2.3 I/O Data

You will find the bit assignment for the transferred I/O data in the following table.

Direction	Byte	Bit	Meaning
Input	0		General
		0	Device status
		1	Signal contact 1
		2	Signal contact 2
		3	Temperature
		4	Fan
		5	Module removal
		6	ACA removal
Input	1		Power supply status
		0	Power supply unit 1
		1	Power supply unit 2
		2	Power supply unit 3
		3	Power supply unit 4
		4	Power supply unit 5
		5	Power supply unit 6
		6	Power supply unit 7
Input	2		Supply voltage status
		0	HIPER-Ring
		1	Ring/Network coupling
		2	Connection error
		3	Not used
		4	Not used
		5	Not used
		6	Not used
Output			Not defined
Meaning of the bit content:			
- 0: OK or unavailable			
- 1: Reason for report exists			

Table 17: Device I/O data

Direction	Byte	Bit	Meaning
Input	0		Connection status for ports 1 to 8
		0	Port 1
		1	Port 2
		2	Port 3
		3	Port 4
		4	Port 5
		5	Port 6
		6	Port 7
Input	1		Connection status for ports 9 to 16
		0	Port 9
		1	Port 10
		2	Port 11
		3	Port 12
		4	Port 13
		5	Port 14
		6	Port 15
Input	n		Connection for port $(n * 8) + 1$ to port $(n * 8) + 8$
		0	Port $(n * 8) + 1$
		1	Port $(n * 8) + 2$
		2	Port $(n * 8) + 3$
		3	Port $(n * 8) + 4$
		4	Port $(n * 8) + 5$
		5	Port $(n * 8) + 6$
		6	Port $(n * 8) + 7$
	7	Port $(n * 8) + 8$	
Meaning of the bit content:			
- 0: no connection			
- 1: connection active			
Output	0		“Port activated” for ports 1 to 8
		0	Port 1 activated
		1	Port 2 activated
		2	Port 3 activated
		3	Port 4 activated
		4	Port 5 activated
		5	Port 6 activated
		6	Port 7 activated
	7	Port 8 activated	

Table 18: Port I/O data

Direction	Byte	Bit	Meaning
Output	1		“Port activated” for ports 9 to 16
		0	Port 9 activated
		1	Port 10 activated
		2	Port 11 activated
		3	Port 12 activated
		4	Port 13 activated
		5	Port 14 activated
		6	Port 15 activated
	7	Port 16 activated	
Output	n		“Port activated” for port $(n * 8) + 1$ to port $(n * 8) + 8$
		0	Port $(n * 8) + 1$ activated
		1	Port $(n * 8) + 2$ activated
		2	Port $(n * 8) + 3$ activated
		3	Port $(n * 8) + 4$ activated
		4	Port $(n * 8) + 5$ activated
		5	Port $(n * 8) + 6$ activated
		6	Port $(n * 8) + 7$ activated
	7	Port $(n * 8) + 8$ activated	
Meaning of the output bit content:			
- 0: Port activated			
- 1: Port deactivated			

Table 18: Port I/O data

## 4 IEC 61850/MMS (RSR20/RSR30/MACH1000)

IEC 61850/MMS is an industrial communication protocol standardized by the International Electrotechnical Commission (IEC). The protocol is to be found in substation automation, e.g. in the control technology of energy suppliers.

This protocol, which works in a packet-oriented way, is based on the TCP/IP transport protocol and uses the Manufacturing Messaging Specification (MMS) for the client-server communication. The protocol is object-oriented and defines a standardized configuration language that comprises, among other things, functions for SCADA, Intelligent Electronic Devices (IED) and for the network control technology.

Part 6 of the IEC 61850 standard defines the configuration language SCL (Substation Configuration Language). SCL describes the properties of the device and the system structure in an automatically processable form. The properties of the device described with SCL are stored in the ICD file on the device.

## 4.1 Switch model for IEC 61850

Technical Report IEC 61850 90-4 specifies a bridge model. The bridge model represents the functions of a switch as objects of an Intelligent Electronic Device (IED). An MMS client (e.g. the control room software) uses these objects to monitor and configure the device.

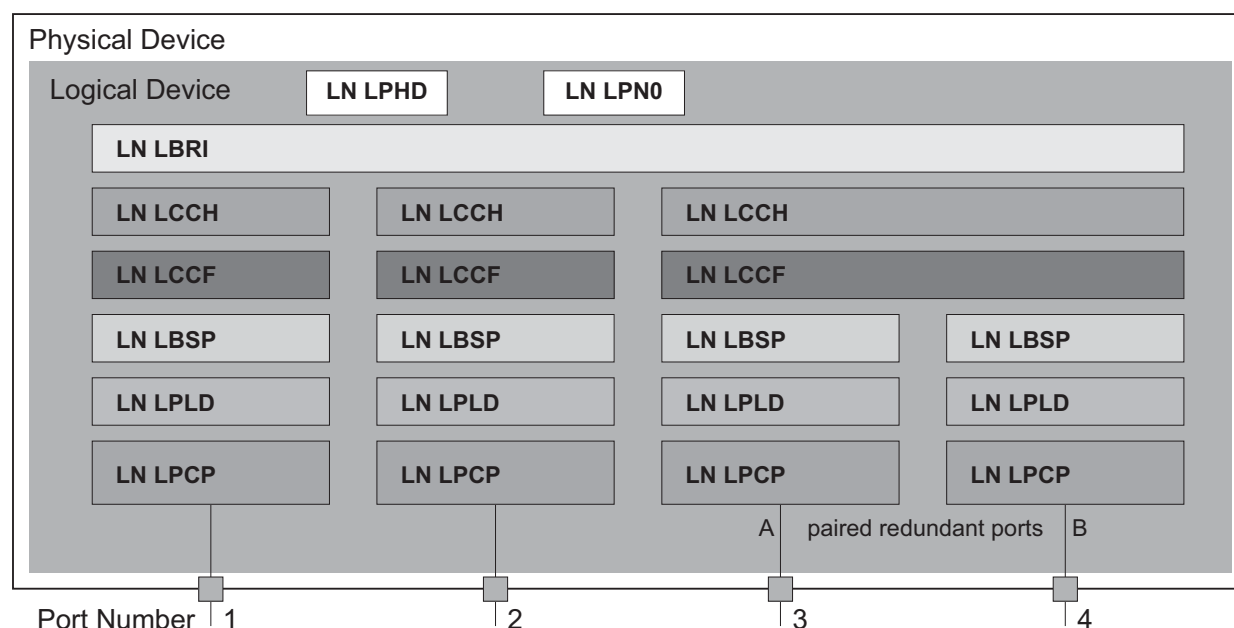

Figure 25: Bridge model based on Technical Report IEC 61850 90-4

Class	Description
LN LLN0	“Zero” logical node of the “Bridge” IED: Defines the logical properties of the device.
LN LPHD	“Physical Device” logical node of the “Bridge” IED: Defines the physical properties of the device.
LN LBRI	“Bridge” logical node: Represents general settings of the bridge functions of the device.
LN LCCH	“Communication Channel” logical node: Defines the logical “Communication Channel” that consists of one or more physical device ports.

Table 19: Classes of the bridge model based on TR IEC61850 90-4

<b>Class</b>	<b>Description</b>
LN LCCF	“Channel Communication Filtering” logical node: Defines the VLAN and Multicast settings for the higher-level “Communication Channel”.
LN LBSP	“Port Spanning Tree Protocol” logical node: Defines the Spanning Tree statuses and settings for the respective physical device port.
LN LPLD	“Port Layer Discovery” logical node: Defines the LLDP statuses and settings for the respective physical device port.
LN LPCP	“Physical Communication Port” logical node: Represents the respective physical device port.

*Table 19: Classes of the bridge model based on TR IEC61850 90-4 (cont.)*

## 4.2 Integration into a Control System

### 4.2.1 Preparing the Switch

After installing and connecting the Switch, you configure it according to the “Basic Configuration” user manual:

- Check that an IP address is assigned to the device.
- To start the MMS server, activate the function in the graphical user interface, in the `Advanced:Industry Protocols:IEC61850` dialog. Afterwards, an MMS client is able to connect to the device and to read and monitor the objects defined in the bridge model.





## WARNING

### **RISK OF UNAUTHORIZED ACCESS TO THE DEVICE**

IEC61850/MMS does not provide any authentication mechanisms. If the write access for IEC61850/MMS is activated, every client that can access the device using TCP/IP is capable of changing the settings of the device. This in turn can result in an incorrect configuration of the device and to failures in the network.

Only activate the write access if you have taken additional measures (e.g. Firewall, VPN, etc.) to eliminate the risk of unauthorized access.

**Failure to follow these instructions can result in death, serious injury, or equipment damage.**

- To enable the MMS client to configure the objects defined in the bridge model, you select the "Write Access" checkbox.

### 4.2.2 Offline configuration

The device enables you to download the ICD file using the graphical user interface. This file contains the properties of the device described with SCL and enables the substation to be configured without a direct connection to the device.

- You download the ICD file by clicking the "Download ICD File" button in the `Advanced:Industry Protocols:IEC61850` dialog.

### 4.2.3 Monitoring the device

The IEC61850/MMS server integrated into the device allows you to monitor multiple statuses of the device by means of the Report Control Block (RCB). Up to 5 MMS clients can register for a Report Control Block at the same time.

The device allows the following statuses to be monitored:

Class	RCB object	Description
LN LPHD	PwrSupAlm	Changes when one of the redundant power supplies fails or starts operating again.
	TmpAlm	Changes when the temperature measured in the device exceeds or falls below the set temperature thresholds.
	PhyHealth	Changes when the status of the "LPHD.PwrSupAlm" or "LPHD.TmpAlm" RCB object changes.
LN LBRI	Health	Changes when the status of the "LPHD.PwrSupAlm" or "LPHD.TmpAlm" RCB object changes.
	RstpRoot	Changes when the device takes over or relinquishes the role of the root bridge.
	RstpTopoCnt	Changes when the topology changes due to a change of the root bridge.
LN LCCH	ChLiv	Changes when the link status of the physical port changes.
LN LPCP	PhyHealth	Changes when the link status of the physical port changes.

*Table 20: Statuses of the device that can be monitored with IEC 61850/MMS*

# A GSD File Generator

The program “Stand-alone GSD File Generator” is located on the product CD. The program allows you to generate a GSD file (PROFINET IO) and/or an EDS file (Ethernet/IP, EDS file from a later release onward) with icon from a non-existent device. You can use these files to configure devices in your engineering station that are not installed in the network yet.

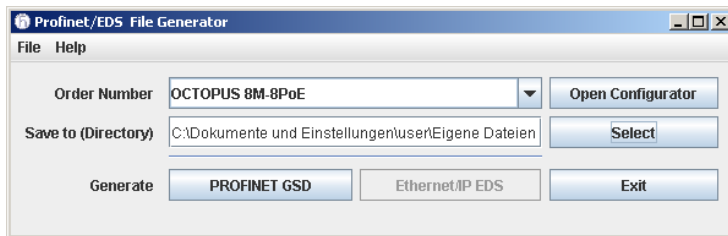

Figure 26: Stand-alone GSD file generator

## B Readers' Comments

What is your opinion of this manual? We are constantly striving to provide as comprehensive a description of our product as possible, as well as important information to assist you in the operation of this product. Your comments and suggestions help us to further improve the quality of our documentation.

Your assessment of this manual:

	Very Good	Good	Satisfactory	Mediocre	Poor
Precise description	<input type="radio"/>	<input type="radio"/>	<input type="radio"/>	<input type="radio"/>	<input type="radio"/>
Readability	<input type="radio"/>	<input type="radio"/>	<input type="radio"/>	<input type="radio"/>	<input type="radio"/>
Understandability	<input type="radio"/>	<input type="radio"/>	<input type="radio"/>	<input type="radio"/>	<input type="radio"/>
Examples	<input type="radio"/>	<input type="radio"/>	<input type="radio"/>	<input type="radio"/>	<input type="radio"/>
Structure	<input type="radio"/>	<input type="radio"/>	<input type="radio"/>	<input type="radio"/>	<input type="radio"/>
Comprehensive	<input type="radio"/>	<input type="radio"/>	<input type="radio"/>	<input type="radio"/>	<input type="radio"/>
Graphics	<input type="radio"/>	<input type="radio"/>	<input type="radio"/>	<input type="radio"/>	<input type="radio"/>
Drawings	<input type="radio"/>	<input type="radio"/>	<input type="radio"/>	<input type="radio"/>	<input type="radio"/>
Tables	<input type="radio"/>	<input type="radio"/>	<input type="radio"/>	<input type="radio"/>	<input type="radio"/>

Did you discover any errors in this manual?  
If so, on what page?

---



---



---



---



---



---



---



---

## Readers' Comments

---

Suggestions for improvement and additional information:

---

---

---

---

General comments:

---

---

---

---

Sender:

---

Company / Department:

---

Name / Telephone number:

---

Street:

---

Zip code / City:

---

E-mail:

---

Date / Signature:

---

Dear User,

Please fill out and return this page

- ▶ as a fax to the number +49 (0)7127/14-1600 or
- ▶ per mail to

Hirschmann Automation and Control GmbH  
Department 01RD-NT  
Stuttgarter Str. 45-51  
72654 Neckartenzlingen



# C Index

<		R	
<VAR~HiVision>Industrial HiVision<~VAR>	5	Record	44, 54
A		Redundancy	5
Alarm	54	Request Packet Interval	17
Alarm setting	36	Router Function	15
C		RPI	17
CIP	13	RS Who	15
Common Industrial Protocol	13	S	
Conformity class	33	Simatic S7	37
D		Symbol	7
Device description language	33	T	
E		TCP/IP	13, 33
EDS	15, 67	Technical Questions	73
Engineering Station	48, 49	Threshold value	36
Engineering system	37	Training Courses	73
EtherNet/IP website	14	U	
F		UDP/IP	13, 33
FAQ	73		
G			
Generic Ethernet Module	16		
GSD	36, 38, 67		
GSD file	38		
GSDML	33		
GSDML File Generator	36, 37		
I			
Icon	15, 36, 38		
IEC 61850	61		
IGMP Snooping	15		
Industry Protocols	5		
M			
MMS	61		
Module properties	42		
O			
ODVA	13		
ODVA website	14		
P			
PC Worx	37		
PROFIBUS Organization	33		
PROFINET IO	5		





## D Further Support

### ■ Technical Questions

For technical questions, please contact any Hirschmann dealer in your area or Hirschmann directly.

You will find the addresses of our partners on the Internet at

<http://www.hirschmann.com>

Contact our support at

<https://hirschmann-support.belden.eu.com>

You can contact us

in the EMEA region at

- ▶ Tel.: +49 (0)1805 14-1538
- ▶ E-mail: [hac.support@belden.com](mailto:hac.support@belden.com)

in the America region at

- ▶ Tel.: +1 (717) 217-2270
- ▶ E-mail: [inet-support.us@belden.com](mailto:inet-support.us@belden.com)

in the Asia-Pacific region at

- ▶ Tel.: +65 6854 9860
- ▶ E-mail: [inet-ap@belden.com](mailto:inet-ap@belden.com)

### ■ Hirschmann Competence Center

The Hirschmann Competence Center is ahead of its competitors:

- ▶ Consulting incorporates comprehensive technical advice, from system evaluation through network planning to project planning.
- ▶ Training offers you an introduction to the basics, product briefing and user training with certification.

The current technology and product training courses can be found at

<http://www.hicomcenter.com>

- ▶ Support ranges from the first installation through the standby service to maintenance concepts.

With the Hirschmann Competence Center, you have decided against making any compromises. Our client-customized package leaves you free to choose the service components you want to use.

Internet:

<http://www.hicomcenter.com>





**HIRSCHMANN**

---

A **BELDEN** BRAND